

POWERLOK RACK PDU SPECIFICATION

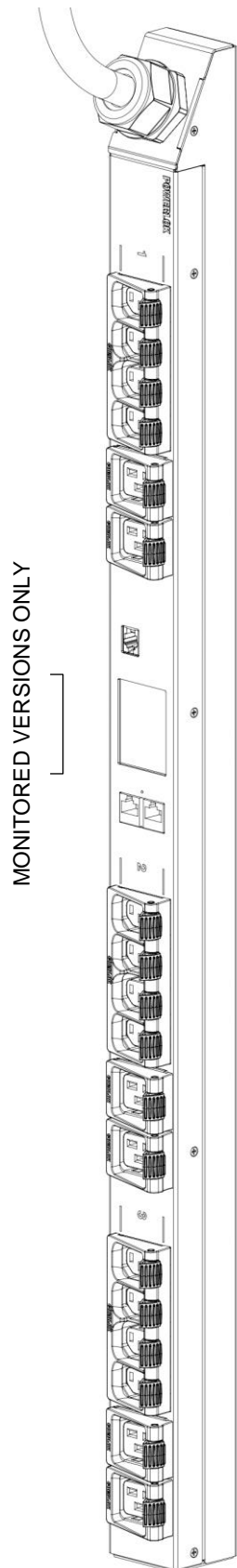

Specific Configurations								
COLOR	CARBON		RED		WHITE		BLUE	
WHIP LENGTH	6 FT	10 FT	6 FT	10 FT	6 FT	10 FT	6 FT	10 FT
MONITORED MODEL	UP8722M-06C	UP8722M-10C	UP8722M-06R	UP8722M-10R	UP8722M-06W	UP8722M-10W	UP8722M-06B	UP8722M-10B
SWITCHED READY MODEL	UP8722S-06C	UP8722S-10C	UP8722S-06R	UP8722S-10R	UP8722S-06W	UP8722S-10W	UP8722S-06B	UP8722S-10B
DESCRIPTION	RACK PDU, 36", 20A 240/415V WYE 3PH, 18-C13 & 3-C19, IEC 309 (IP44), CORDLOK							
MONITORING	REMOTE COMM & UNIT DISPLAY, ENVIROLOK READY							
SWITCHING	REMOTE COMM & UNIT DISPLAY, ENVIROLOK READY, SWITCHLOK READY							
POWER	20A 240/415V WYE 3PH (11.5 kW)							
PLUG TYPE	IEC 309 (IP44)							
UNIT LENGTH	36 INCHES							
RECEPTACLES	18-C13 & 3-C19							
CORDLOK	YES							

Universal Specification	
Over Current Protection	None
Power Whip	See PDU Ratings Table - page 2
Heavy Steel - Powder Coat Color	Per PowerLok specific configuration for color
Rack PDU Type	Vertical Rack-mount
Toolless Mounting: Center Spacing	24.50"
Manufactured in the USA	Yes
Product Warranty	3-year from date of shipment, repair or replace.
Certification/Agency Approvals	TUV Certified to UL/CSA 60950-1 with NOM Addendum for Mexico, FCC Part 15 Class A conformance, RoHS compliant
Operating Environment	0-60C (32-149F), 5-95% relative humidity, 0-10,000ft (0-3000 meters) elevation.
Storage Environment	-25-65C (-13-149F), 5-95% relative humidity, 0-10,000ft (0-3000 meters) elevation.
Chassis Dimensions (LxWxD)	36"L x 2.18"W x 2.0"D
Package Dimensions (LxWxD)	49.0"L x 22.0"W x 4.8"D (3&4-Pack), 49.0"L x 11.0"W x 4.8"D (1&2-Pack)
Pallet Dimensions (LxWxD)	49"L x 44"W x 5.0"D
Rack PDU Weight	11.3 lbs.
Packaged Weight (each)	13.3 lbs.

Monitored & Switched Versions Only	
Monitoring Accuracy	Voltage: +/- 0.5% at nominal. Current: within 0.5% from 1A to 30A typical. +/-1% of measurement from 500mA to 30A.
Total Unit & Group Monitoring	Aggregate (kWh, W, VA) plus Phase: A, B, C Line Currents, plus Group: 1, 2, 3 Monitoring (kWh, W, VA, PF, V, A)
Network Interface	Ethernet RJ-45, 10 Mbit/s, 100 Mbit/s
Transport/Internet	TCP/IP v4, v6
Network Applications	HTTP/HTTPS Webserver SNMP-V1/V2c/V3 Network Management DHCP for dynamic IP address request from a server on the network. Remote firmware upgrade using FTP.
Touch & Rotatable Digital Display	Touch to rotate / touch to view data screens
Internal RMS Voltage Sensor	Yes
Internal RMS Current Sensor	Yes
Environmental Monitoring	Optional EnviroLok daisy chain temp/humidity (optional - up to 4 sensors). Monitoring accuracy +/- 0.2C and +/- 2% Rh.

MADE AND ROBOTICALLY SOLDERED IN THE USA

POWERLOK

*CUSTOMER SIGNATURE:	DATE:	UNLESS OTHERWISE SPECIFIED, ALL DIMENSIONS ARE IN MM AND TOLERANCES ARE: X = +/- 0.5 .X = +/- 0.25 .XX = +/- 0.13 X' = +/- 0.5'	Upsite Technologies	
*PRIOR TO MANUFACTURING, BUILD MODELS REQUIRE CUSTOMER SIGN-OFF. BY SIGNING, CUSTOMER AGREES THAT THIS ORDER IS NON-CANCELABLE AND NON-RETURNABLE.			TITLE: RACK PDU SPECIFICATION	DRAWING NUMBER: SP-UP8722
THIS SPECIFICATION AND ITS CONTENTS ARE THE PROPERTY OF Upsite Technologies AND SHALL NOT BE COPIED OR REPRODUCED FOR ANY PURPOSES OTHER THAN APPLICATION OF PRODUCT MANUFACTURED BY Upsite Technologies. THIS DRAWING IS SUBJECT TO CHANGE WITHOUT NOTICE.				

Example drawing shown. See table for actual receptacle configuration.

OUTLINE DRAWING

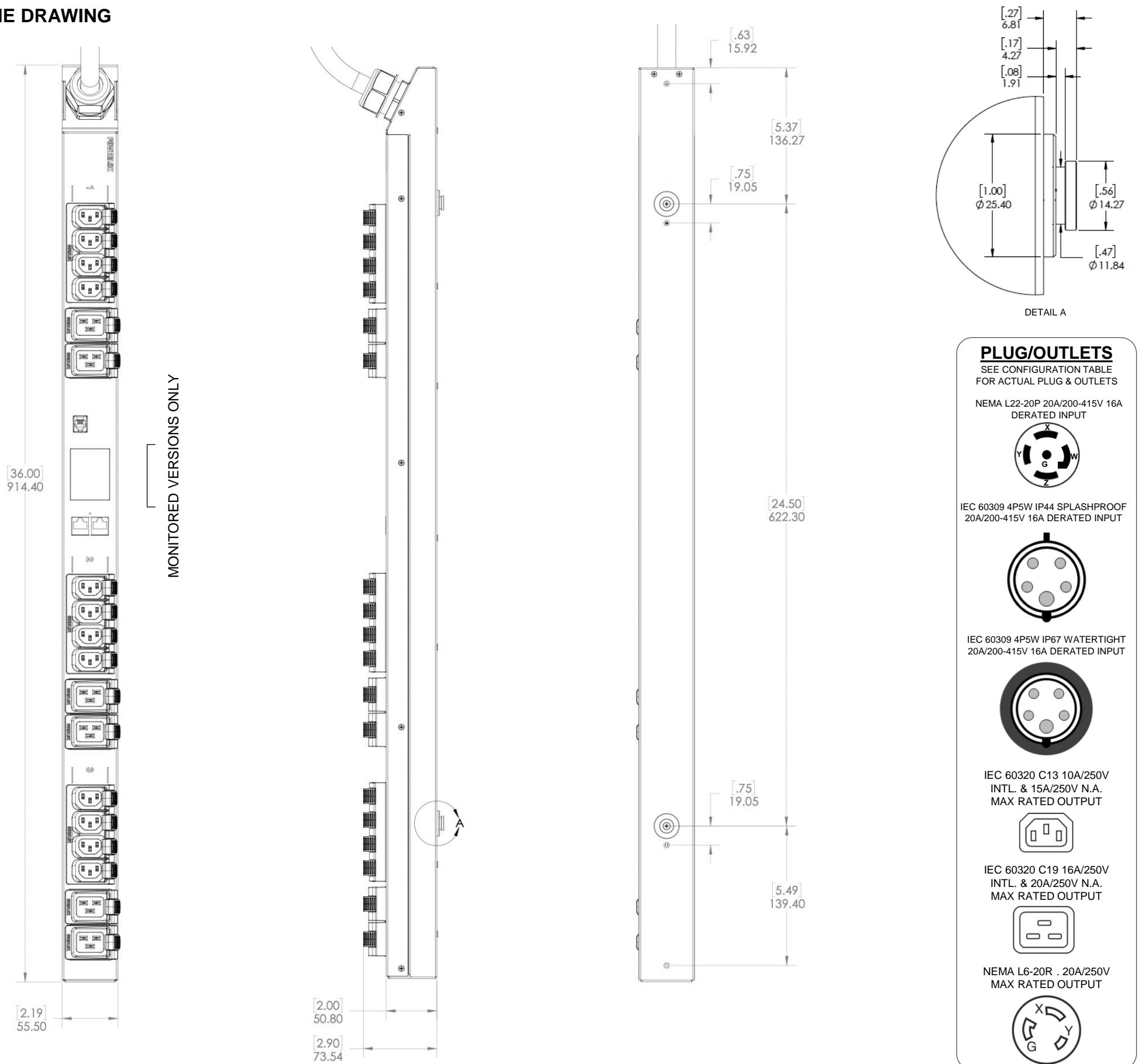

MONITORED VERSIONS ONLY

PLUG/OUTLETS

SEE CONFIGURATION TABLE FOR ACTUAL PLUG & OUTLETS

NEMA L22-20P 20A/200-415V 16A DERATED INPUT

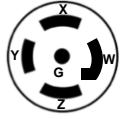

IEC 60309 4P5W IP44 SPLASHPROOF 20A/200-415V 16A DERATED INPUT

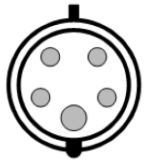

IEC 60309 4P5W IP67 WATERTIGHT 20A/200-415V 16A DERATED INPUT



IEC 60320 C13 10A/250V INTL. & 15A/250V N.A. MAX RATED OUTPUT

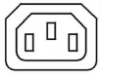

IEC 60320 C19 16A/250V INTL. & 20A/250V N.A. MAX RATED OUTPUT

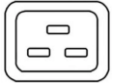

NEMA L6-20R . 20A/250V MAX RATED OUTPUT



PDU WIRING DIAGRAM & RATINGS TABLE

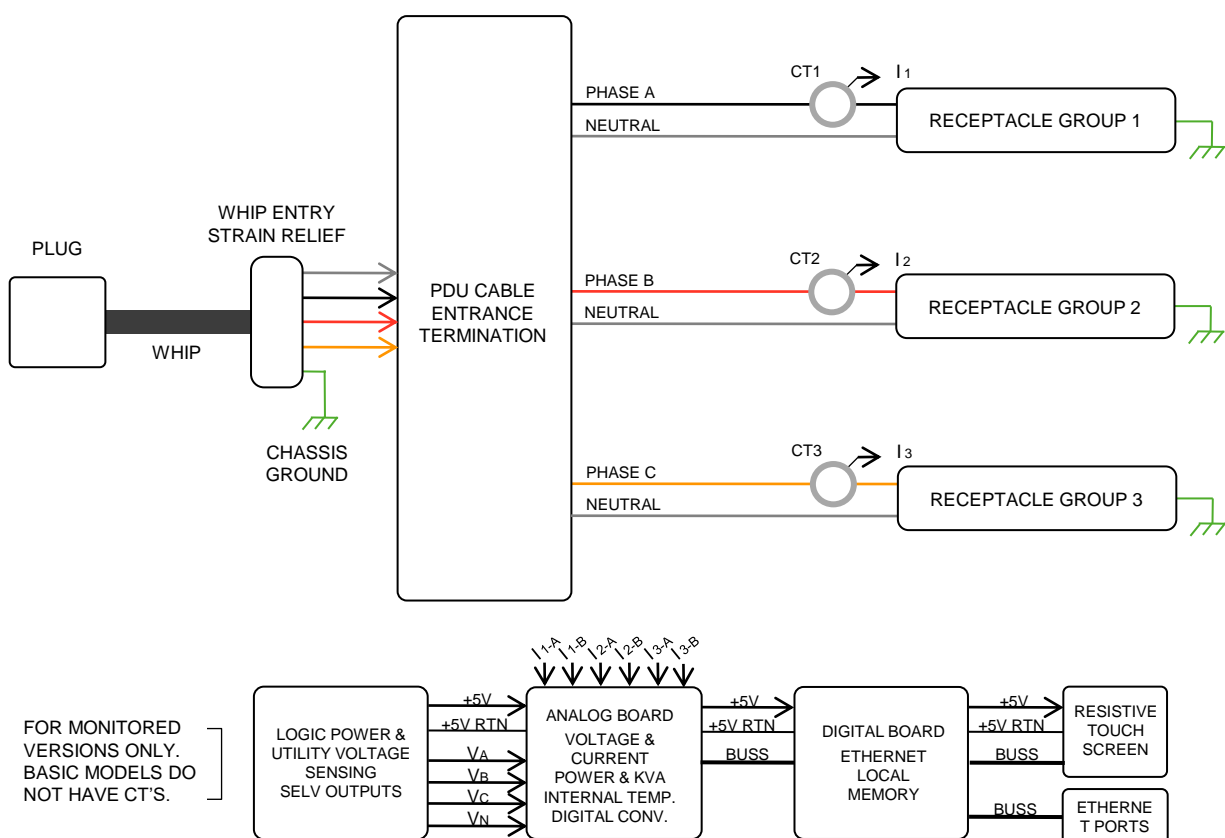

FOR MONITORED VERSIONS ONLY. BASIC MODELS DO NOT HAVE CT'S.

INPUT POWER:	
WHIP TYPE	12GA 5-WIRE SOOW
VOLTAGE	240/415V WYE 3PH
FREQUENCY	50/60 HZ
RATED AMPS	20A
MAX CONT. AMPS	16A
OUTPUT POWER:	
GROUP 1	PH A-N, 16A MAX CONT.
GROUP 2	PH B-N, 16A MAX CONT.
GROUP 3	PH C-N, 16A MAX CONT.

MADE AND ROBOTICALLY SOLDERED IN THE USA

POWERLOK

*CUSTOMER SIGNATURE:	DATE:	UNLESS OTHERWISE SPECIFIED, ALL DIMENSIONS ARE IN MM AND TOLERANCES ARE: X = +/- 0.5 .X = +/- 0.25 .XX = +/- 0.13 X' = +/- 0.5"	Upsite Technologies	
*PRIOR TO MANUFACTURING, BUILD MODELS REQUIRE CUSTOMER SIGN-OFF. BY SIGNING, CUSTOMER AGREES THAT THIS ORDER IS NON-CANCELABLE AND NON-RETURNABLE.			TITLE: RACK PDU SPECIFICATION	
		DRAWING NUMBER: SP-UP8722	SHEET: 2 OF 2	
THIS SPECIFICATION AND ITS CONTENTS ARE THE PROPERTY OF Upsite Technologies AND SHALL NOT BE COPIED OR REPRODUCED FOR ANY PURPOSES OTHER THAN APPLICATION OF PRODUCT MANUFACTURED BY Upsite Technologies. THIS DRAWING IS SUBJECT TO CHANGE WITHOUT NOTICE.				